

Single turn Potentiometer

ET3362 Cermet Trimming Potentiometer

EIECSOUND®

Square/Single-Turn/ Cermet/ Industrial/ Sealed

10 Terminal Styles

Rohs Compliant

Electrical Characteristics

Standard Resistance Range: 10Ω - 2MΩ
 Resistance Tolerance: ±10% std.
 Absolute Minimum Resistance: ≤1% or 2Ω
 Contact Resistance Variation: ≤3% or 3Ω
 Insulation Resistance : R1 ≥ 1,000 MegΩ
 Withstand Voltage : 700VAC
 Effective Travel: 250° normal

Environmental Characteristics

Power Rating:(315V max)0.5W@70°C,0W@125°C
 Temperature Range: -55°C to +125°C
 Temperature Coefficient: ±100ppm/°C
 Vibration:10-500Hz,0.75mm,6Hour:ΔR≤±5%
 Shock: 390m/s, 4000cycles, ΔR≤±5%
 Endurance:0.5W@70°C,1000H,ΔR≤±10%
 Rotational Life: 200Cycles,ΔR≤±5%

Physical Characteristics

Starting Torque: ≤30mN-m
 Flammability: UL-94V-0
 Marking: Resistance code, Model
 Standard Packaging: 50pcs per tube

How To Order:

ET3362 P - 1 - 502

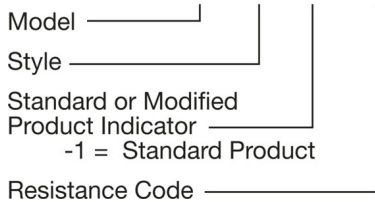

Standard Resistance Table:

Resistance (Ohms)	Resistance Code
10	100
20	200
50	500
100	101
200	201
500	501
1000	102
2000	202
5000	502
10000	103
20000	203
25000	253
50000	503
100000	104
200000	204
250000	254
500000	504
1000000	105
2000000	205

Special Resistance Available

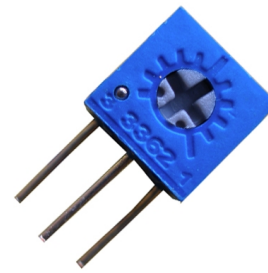
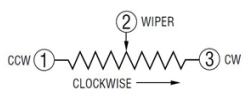

ET3362 Common Dimension

Top Adjust

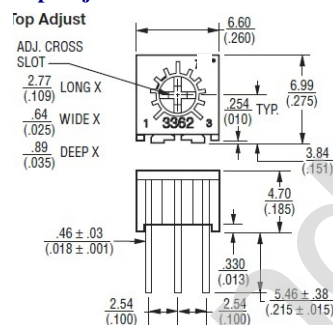

Side Adjust

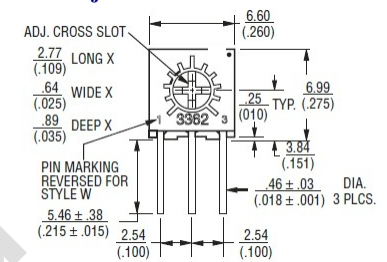

ET3362 Adjust Method

ET3362F

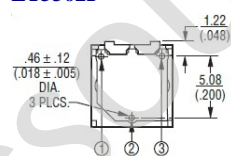

ET3362H

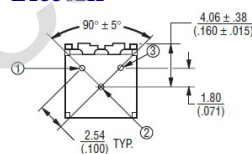

ET3362P

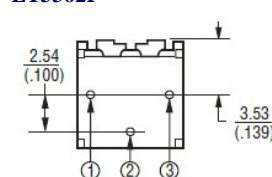

ET3362R

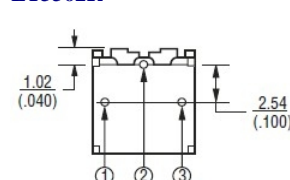

ET3362U

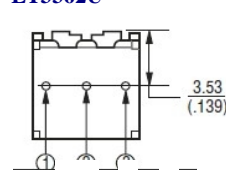

ET3362M

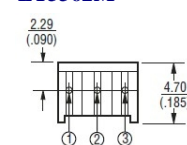

ET3362S

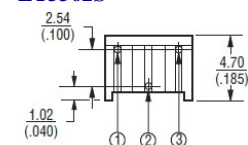

ET3362W

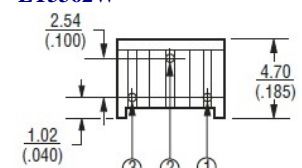

ET3362X

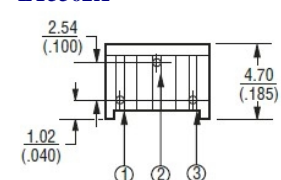

ET3362Z

